

Type:
Job:
Catalog number:

____ / ____ / ____ / ____
 Mtg. Fixture Electrical Module Finish Options
 See page 2 See pages 3-4

Approvals:

Date:
Page: 1 of 4

Select pole from Kim Pole Catalog. If pole is provided by others indicate O.D. for arm fitting.

Specifications

WP9LE-LED
 Large Electronic
 120 Light Emitting Diodes
 Total Max System Watts = 175W

Maximum weight:
 35 lb. electronic

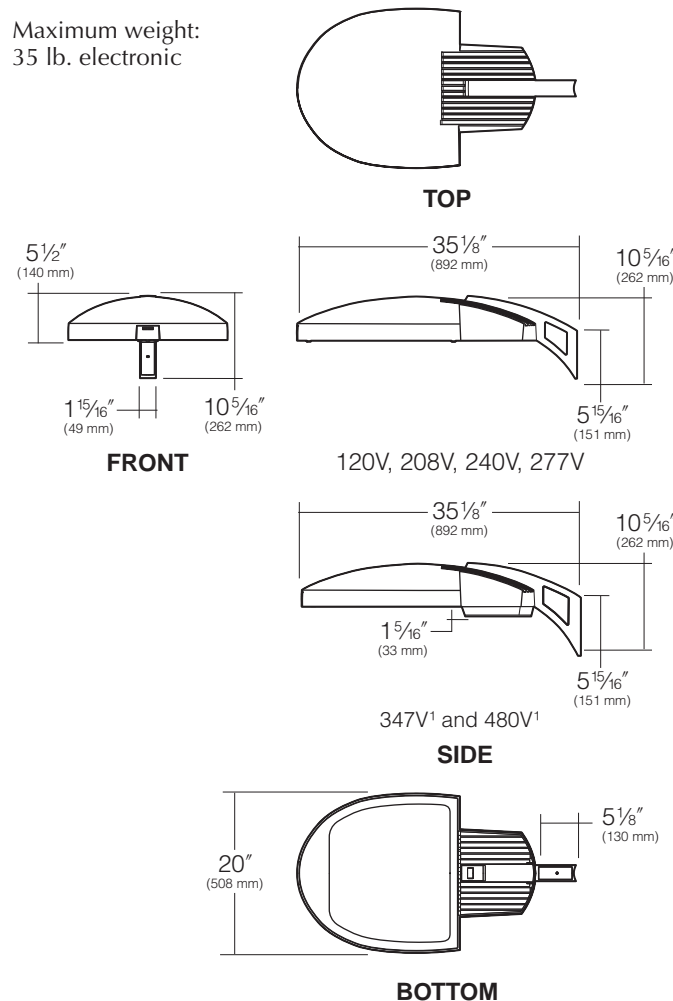

NOTE: Driver compartment door extends down 1 5/16" on large housing to accommodate integral step-down transformer on 347V and 480V models only.

Housing: One-piece die-cast, low copper (<0.6% Cu) aluminum alloy with integral cooling ribs over the electrical compartment. Solid barrier wall separates optical and electrical compartments. A single die-cast aluminum cam-latch provides positive locking and sealing of the optical chamber. A one-piece extruded and vulcanized silicone gasket seals the housing against the lens surface.

Electronic Driver Module: One-piece die-cast, low copper (<0.6% Cu) aluminum alloy with integral cooling ribs over exposed bottom surface. Integral hinges and slide latch with stainless steel hardware provides no-tool mounting and removal from housing. All electronic components are UL and CSA recognized and mounted directly to the driver tray for maximum heat dissipation.

Lens: Clear 3/16" thick tempered glass lens retained by a stainless steel piano hinge and a single die-cast aluminum cam-latch. The edges are camouflaged to conceal the outer portion of the housing.

Optical Module: Precision injection molded, high specular reflectors are positioned to achieve directional control toward desired task. Secondary high specular reflector 95% Miro4 panels surround the module to redirect light downward. No fasteners are placed on the reflective surface. The entire assembly fastens to the housing as a one-piece module.

Support Arm: Heavy cast, low copper aluminum alloy with stainless steel mounting bolts. A pole reinforcing plate is provided with wire strain relief. Arm is circular cut for specified round pole.

Finish: Super TGIC thermoset polyester powder coat paint, 2.5 mil nominal thickness, applied over a titanated zirconium conversion coating; 2500 hour salt spray test endurance rating. Standard colors are Black, Dark Bronze, Stealth Gray™, Platinum Silver, or White. Custom colors are available

CAUTION: Fixtures must be grounded in accordance with national, state and/or local electrical codes, Failure to do so may result in serious personal injury.



**U.S. Patent D568,521,
 Patent Pending Optics**

Listings and Ratings			
UL cUL 1598 ¹	CE	IP66 Rated	25C Ambient

¹Suitable for wet locations.

KIM LIGHTING RESERVES THE RIGHT TO CHANGE SPECIFICATIONS WITHOUT NOTICE.

Type:

Job:

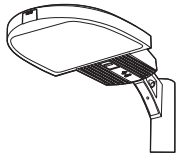

Standard Features

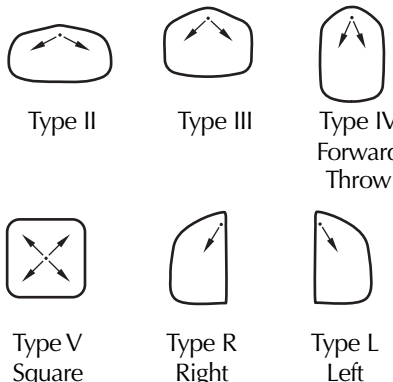
<p>Mounting 3Y configuration is available for round poles only.</p>	<p>Plan View:</p>  <p>EPA: 0.95 1.9 1.47 2.4 2.4 2.7 n/a</p> <p>Cat. No.: <input type="checkbox"/> 1A <input type="checkbox"/> 2B <input type="checkbox"/> 2L <input type="checkbox"/> 3T <input type="checkbox"/> 3Y <input type="checkbox"/> 4C <input type="checkbox"/> 1W</p>
<p>Fixture Cat. No. designates fixture and light distribution.</p>	<p>WP9 L E x</p> <p>Housing: WP9=WARP9</p> <p>Driver: E=Electronic</p> <p>Size: L=Large, 120 LEDs, 175W</p> <p>Distribution:</p> <p><input type="checkbox"/> 2=Type II Full Cutoff <input type="checkbox"/> 3=Type III Full Cutoff <input type="checkbox"/> 4=Type IV Full Cutoff <input type="checkbox"/> 5=Type V Square Full Cutoff <input type="checkbox"/> R=Type R Right Full Cutoff <input type="checkbox"/> L=Type L Left Full Cutoff</p> <p>Light Distribution:</p>  <p>Type II Type III Type IV Forward Throw</p> <p>Type V Square Type R Right Type L Left</p>
<p>Electrical Module</p>	<p>L x x</p> <p>Source: L=LED</p> <p>Color Temperature:</p> <p><input type="checkbox"/> 3K=3500K <input type="checkbox"/> 5K=5100K <input type="checkbox"/> 2K=1700K Amber</p> <p>Voltage:</p> <p><input type="checkbox"/> 120=120V <input type="checkbox"/> 208=208V <input type="checkbox"/> 240=240V <input type="checkbox"/> 277=277V <input type="checkbox"/> 347=347V¹ <input type="checkbox"/> 480=480V¹</p> <p>¹Due to current unavailability of 347V and 480V drivers, specification of these voltages shall feature an integral step-down transformer. Driver compartment door extends down 1³/₁₆" on large housing to accommodate transformer.</p>
<p>Finish Super TGIC powder coat paint over a titanated zirconium conversion coating.</p>	<p>Color: Black Dark Bronze Stealth Gray™ Platinum Silver White Custom Color²</p> <p>Cat. No.: <input type="checkbox"/> BL <input type="checkbox"/> DB <input type="checkbox"/> SG <input type="checkbox"/> PS <input type="checkbox"/> WH <input type="checkbox"/> CC</p> <p>²Custom colors subject to additional charges, minimum quantities and extended lead times. Consult representative. Custom color description: _____</p>

Type:

Job:

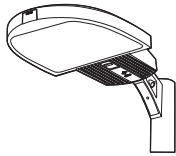

Optional Features

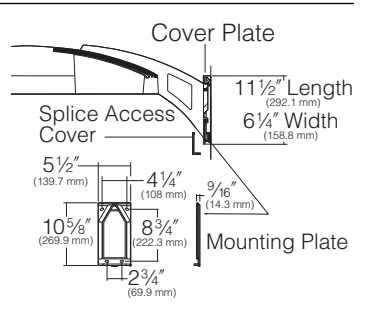
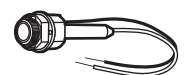
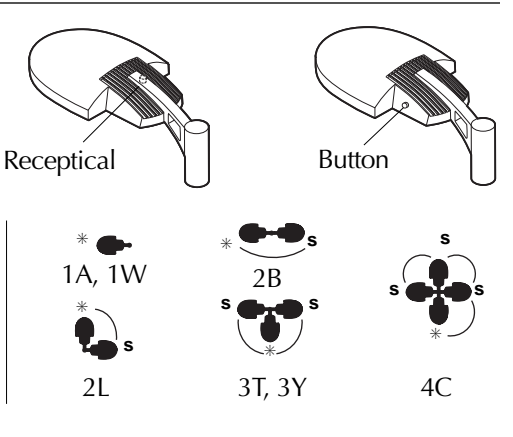
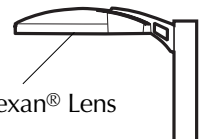
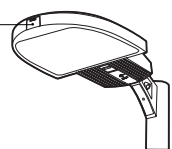
<p>Wall Mounting Cat. No. 1W Select from Mounting on page 2.</p>	<p>A cast aluminum mounting plate is mounted to the wall with four bolts (by others). Fixture and arm are mounted to the cast aluminum cover plate before attaching to the wall mounting plate. The fixture-arm-cover plate assembly is hooked to the wall mounting plate and secured with stainless steel screws provided. Field splices are made at the opening in the cover plate. Cover is finished to match arm and fixture color.</p>	
<p>Fusing (internal only): Cat. No. (see chart at right) <input type="checkbox"/> No Option</p>	<p>High temperature fuse holders factory installed inside the fixture housing. Fuse is included. Line Volts: 120V 208V 240V 277V 347V 480V Cat. No.: <input type="checkbox"/> SF <input type="checkbox"/> DF <input type="checkbox"/> DF <input type="checkbox"/> SF <input type="checkbox"/> SF <input type="checkbox"/> DF</p>	 <p>Single Fuse</p>
<p>Photocell Controls Cat. Nos. <i>receptacle</i> <input type="checkbox"/> A-25 <i>Button</i> <i>Line Volts</i> <input type="checkbox"/> A-30 - 120V <input type="checkbox"/> A-31 - 208V <input type="checkbox"/> A-32 - 240V <input type="checkbox"/> A-33 - 277V <input type="checkbox"/> A-35 - 347V <input type="checkbox"/> A-34 - 480V <input type="checkbox"/> No Option</p>	<p>Two types of photocell controls are available. A receptacle for a NEMA base photocell or an internal photocell button sensor on the side of the fixture. Mounting (see page 2) * – Fixture with Photocell Receptacle S – slave unit(s)</p>	
<p>Lexan® Lens Cat. No. <input type="checkbox"/> LS <input type="checkbox"/> No Option</p>	<p>One-piece flat advanced polymer (Lexan®) replaces standard tempered glass lens. CAUTION: Use only when vandalism is anticipated to be high. For LED use only.</p>	 <p>Lexan® Lens</p>
<p>Tamper-Resistant Latch Cat. No. <input type="checkbox"/> TL <input type="checkbox"/> No Option</p>	<p>Standard die-cast latch is provided with a captive 10-32 stainless steel flat socket-head screw to prevent unauthorized opening. NOTE: Required only for vandal protection in locations where fixtures can be reached by unauthorized persons.</p>	<p>Tamper Resistant Latch</p> 

Type:

Job:

Page: 4 of 4

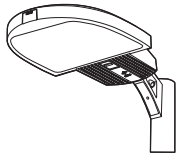

Optional Features

Horizontal Slipfitter Mount

- Cat. No. HSF
 No Option

Replaces standard mounting arm with a cast aluminum fitter to adapt to a horizontal 2" pipe-size mounting end (2 3/8" OD). The casting has a 5° adjustment to accommodate davit arms that are not horizontal. Horizontal pipe must be field drilled at one set screw location to insure against fixture rotation. Finish to match fixture color.

Horizontal Slipfitter

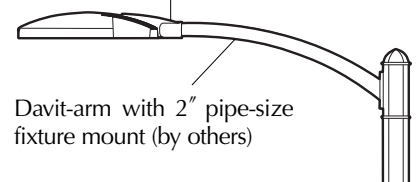

Vertical Slipfitter Mounts

- Cat. No. includes Mounting
 Cat. No. (See right)
 No Option

Allows fixture or fixtures with standard mounting arm to mount to a pole with a 2" pipe-size tenon (2 3/8" OD). Minimum 4" tenon length required.

Specify configuration (1A, 2B, 2L, 3T, 3Y, 4C) 4" round or square aluminum with flush cap. Finish to match fixture and arm.

NOTE: 3Y only available on round slipfitter.

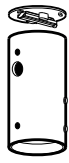
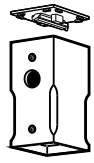
Cat. No.		Stainless steel set screws		Cat. No.	Mounting Configuration
<input type="checkbox"/> VSF-1A				<input type="checkbox"/> SVSF-1A	1A - single arm mount
<input type="checkbox"/> VSF-2B				<input type="checkbox"/> SVSF-2B	2B - 2 at 180°
<input type="checkbox"/> VSF-2L				<input type="checkbox"/> SVSF-2L	2L - 2 at 90°
<input type="checkbox"/> VSF-3T				<input type="checkbox"/> SVSF-3T	3T - 3 at 90°
<input type="checkbox"/> VSF-3Y					3Y - 3 at 120°
<input type="checkbox"/> VSF-4C	Round		Square	<input type="checkbox"/> SVSF-4C	4C - 4 at 90°

Special Options for Street Lighting

- Cat. No. TB
 No Option

Terminal Block (TB): For field wire connections in the Large model only. 85AMP, 600V box clamp terminal block mounted to the housing inside the electrical compartment. Accepts #14 to #4 wire sizes. Factory prewired to electrical module quick-disconnect plug.

Dimming Controls

Kim Lighting is working with several driver suppliers and control system manufacturers to develop a variety of proven turnkey solutions to meet any application's need. Kim Lighting will advise availability of complete control packages, and even two-way monitoring systems, once they have been tested and exceed Kim's high quality standards. Contact factory for further details and current capabilities.